

DORMAKABA expert plus benefits from a high level of security thanks to the sophisticated technology within the locking cylinder. DORMAKABA expert plus locking cylinders protect against the most common opening methods (picking and impact protection).

DORMAKABA expert plus cylinders are ergonomically correct reversible key systems, which means that the DORMAKABA reversible key is inserted vertically into the cylinder channel. The locking positions on each cylinder side are arranged in 4 rows radially around the key. The cylinder is thus reliably protected against illegal opening methods - even with modern tools.

Basic length

- from 30/30 mm
- measured from the middle of cam
- extension 5 mm per side

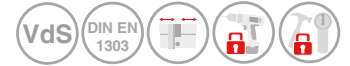

Technical characteristics

- technical and patent copy protection offer high key copy protection
- 4 radially arranged rows of hardened steel pins
- up to 22 pin pairs per cylinder side in several rows on 44 possible positions (over 907 billion possible lockings)
- spring-loaded pairs of locking elements made of hardened steel, chemically nickel plated
- standard drilling protection (hardened steel locking elements and a 4 mm thick fixing screw made of hardened steel additionally on each cylinder side in the cylinder body)
- high security against picking and the impact method
- classic door cylinder in 17 mm Euro profile, core diameter: 15 mm
- modular system design
- tested according to DIN EN 1303:2015 locking security class 6, attack resistance class B in the optional lamella version or with protective fitting
- certifications: DIN 18252-82 I VdS class B and BZ I Kitemark
- other cylinder shapes: e.g. swiss round profile
- patent protection until 2033

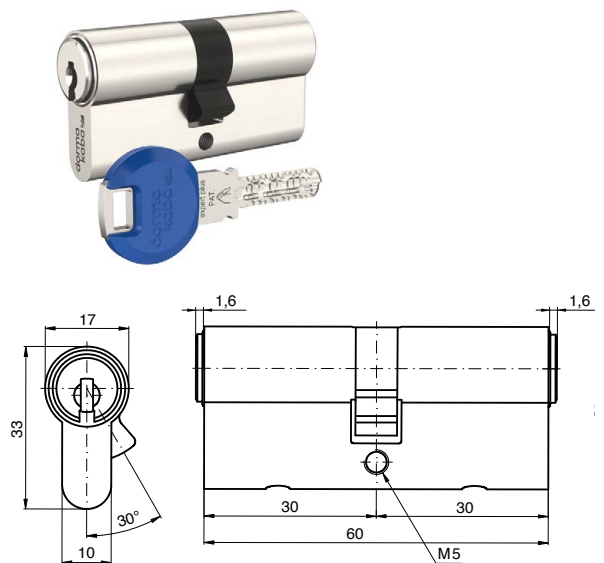

Execution

- ergonomically correct reversible key, i.e. the DORMAKABA reversible key is inserted vertically into the cylinder channel
- easy key insertion due to new design of the locking elements
- cylinder body: nickel-plated brass
- integration into electronic DORMAKABA locking systems with LEGIC Clip possible at any time (retrofitable), mechanical lock remains unchanged

Options / Special equipment

- different cylinder finishes
- increased drilling protection according to VdS B, increased drilling and pulling protection according to VdS BZ
- emergency and danger function (closing on both sides)
- weather protection (SEW) **
- dust and insect protection (SIS) **
- freewheel (from 70 mm total length) **
- long bow with and without key clip

Operational area

- interior doors, exterior doors, front doors, apartment doors
- private houses and apartments
- industry, office buildings, airports, hospitals
- flexibly usable for simple up to complex locking systems

Scope of delivery

- double cylinder incl. 3 or more keys
- 1 fixing screw M5 x 85 mm
- Security card

Key

- key thickness: 2,5 mm
- reversible key made of high-quality nickel silver, low-wear
- reversible key that is technically difficult to copy
- the new coding on the tip of the key cannot be produced with conventional key cutting machines; if the coding is missing, a key cannot be inserted or turned
- high breaking resistance
- 3 different key types, standard key: smartkey (optional largekey, long bow)
- colour clip standard: dark blue (selectable from 12 colours)

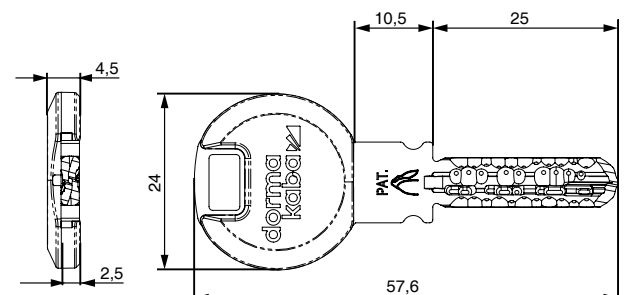

Technical details

Reversible key that is technically difficult to copy

The reversible key is technically difficult to copy. The keys are not coded by drilling, but by a special milling process that conceals the position of the coding on the key. The key is made of nickel silver and is highly resistant to breaking, has excellent sliding properties and lowest wear. New design of the locking elements allow the key to slide even more easily into the key channel.

High security against picking and the impact method

With the rapido method, conventional locking cylinders can be opened - without leaving any traces - with a specially made key and a hammer. The DORMAKABA expert plus system is protected against this.

DORMAKABA modular

The DORMAKABA modular system allows cylinders to be converted to other lengths or even other cylinder shapes on site with little effort. The locking system remains intact. The inserted cylinder cores (inserts) can easily be used in other cylinder designs (half cylinders, knob cylinders, camlock cylinders, etc.).

Standard drilling protection

The standard drilling protection is achieved by standard hardened steel locking elements and a hardened insert fixing screw (A).

This design complies with DIN EN 1303 attack resistance class B.

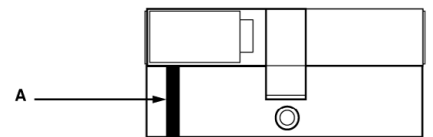

Increased drilling protection - VdS class B approval

By using additional steel elements in the body and insert, a higher resistance to drilling is achieved. Class B locking cylinders do not have an integrated pull-out protection. In combination with a tested core protection fitting, attack resistance class D is achieved.

A = insert with two carbide longitudinal pins = BS

B = tungsten carbide stud

C = short insert fixing screw hardened at the front

D = long insert fixing screw hardened at the rear

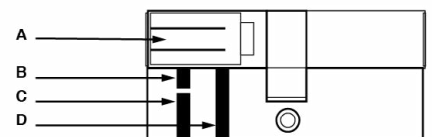

Increased drilling and pulling protection - VdS class BZ

By using additional steel elements in the body and insert, a higher resistance to drilling is achieved. The increased pulling protection values are achieved by means of a pulling protection pin. The new DORMAKABA VdS cylinder protects against pulling even in tubular frame doors. These cylinders can be used without protective fittings and achieve attack resistance class D without a tested core protection fitting.

A = insert with carbide pins = BS

B = tungsten carbide stud

C = bible screw

D = insert fixing screw hardened

E = steel lamella

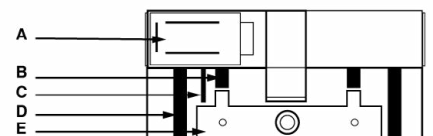

Largekey (clip and long bow)

- long key bow with extended key neck
- colour clip standard: dark blue (selectable from 12 colors)
- when using e.g. protective fittings with core pulling protection rosette

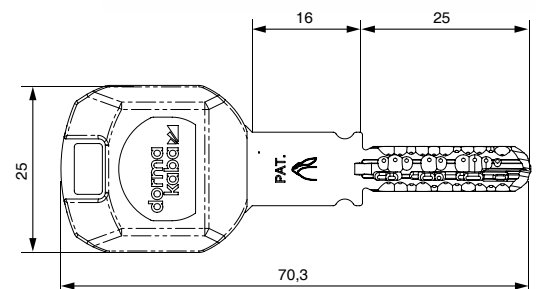

Long bow (armour bow)

- reversible key with armour bow
- when using e.g. security fittings with core pulling protection rosette and multiple locking systems

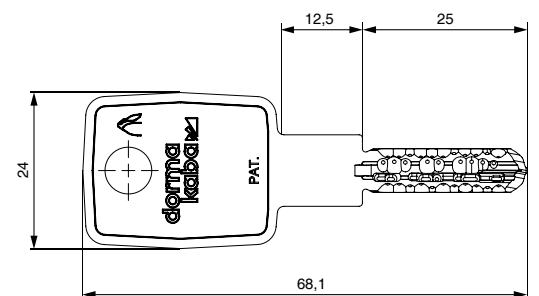

** on request