

The DORMAKABA penta system is a very flexible system and meets the highest security requirements both in the private sector and for large and complex installations. DORMAKABA penta offers a high level of security thanks to the sophisticated technology within the locking cylinder. This is achieved by 5 radial pin rows with up to 22 pin positions. High-quality materials such as low-wear chrome nickel steel for the pins and nickel silver for the key are also decisive. DORMAKABA penta locking cylinders are among the most secure on the market and protect against the most common opening methods. DORMAKABA penta locking cylinders are part of an ergonomically correct reversible key system, which means that the DORMAKABA reversible key is inserted vertically into the cylinder channel.

Basic length

- 25/14,5 mm
- measured from the middle of cam



Technical characteristics

- technical and patent copy protection offer high key copy protection
- 5 radially arranged rows of hardened steel pins
- up to 22 pin pairs per cylinder side in several rows on 85 possible positions
- number of possible, theoretical individual blocks: 867 trillion
- spring-loaded pairs of locking elements made of hardened steel, chemically nickel plated
- standard drilling protection (hardened steel locking elements and a 4 mm thick fixing screw made of hardened steel additionally on each cylinder side in the cylinder body)
- very high security against picking and the impact method
- classic door cylinder in 17 mm Euro profile, core diameter: 15 mm
- modular system design
- tested according to DIN EN 1303:2015 locking security class 6, and in conjunction with pull-out protection rosettes or fittings the attack resistance class 2, in optional lamella design the cylinders also fulfil attack resistance class D according to DIN EN 1303 without protective fittings
- certifications: DIN 18252-82 | VdS class B | Kitemark
- different key forms, other cylinder shapes: e.g. swiss round & oval profile
- patent protection until 2033

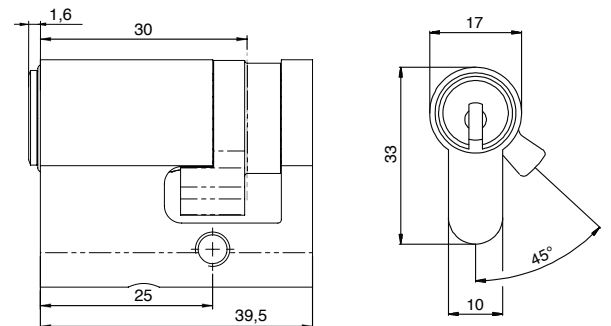

Execution

- ergonomically correct reversible key (vertical key insertion)
- easy key insertion due to new design of the locking elements
- cylinder body: nickel plated brass
- cam: 2 x 12-fold adjustment possible (note: to adjust the cam, you have to open the rear cover either with a cent piece or a very flat slotted screwdriver.)
- integration into electronic DORMAKABA locking systems with LEGIC clip possible at any time (retrofittable), mechanical lock remains unchanged
- can be combined with DORMAKABA evolvo mechatronic locking system

Options / Special equipment

- different cylinder finishes
- increased drilling protection according to VdS B
- priority (the key locks from outside if there is a key inside) **
- weather protection
- long bow with and without key clip

Operational area

- additional locks, garage doors, sheds and side doors
- private houses and apartments, small and medium-sized enterprises
- industrial and administrative buildings, large and complex locking systems
- public facilities such as schools or community buildings

Scope of delivery

- half cylinder short incl. 3 or more keys
- 1 fixing screw M5 x 85 mm
- Security card

Key

- reversible key made of high-quality nickel silver, low-wear
- reversible key that is technically difficult to copy
- the new coding on the tip of the key cannot be produced with conventional key cutting machines; if the coding is missing, a key cannot be inserted or turned
- high breaking resistance
- 3 different key types, standard key: smartkey (optional largekey, long bow)
- colour clip standard: black (selectable from 12 colours)
- new exclusive colour clips only for the DORMAKABA penta system: in elaborate 2-component plastic technology with glossy surface

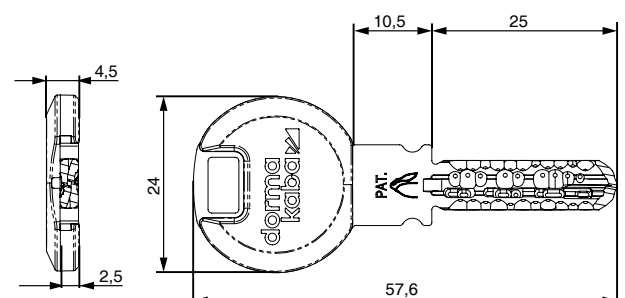

Technical details

Reversible key that is technically difficult to copy

The reversible key is technically difficult to copy. The keys are not coded by drilling, but by a special milling process that conceals the position of the coding on the key. The key is made of nickel silver and is highly resistant to breaking, has excellent sliding properties and lowest wear. New design of the locking elements allow the key to slide even more easily into the key channel.

High security against picking and the impact method

With the rapido method, conventional locking cylinders can be opened - without leaving any traces - with a specially made key and a hammer. The DORMAKABA penta system is protected against this.

DORMAKABA modular

The DORMAKABA modular system allows cylinders to be converted to other lengths or even other cylinder shapes on site with little effort. The locking system remains intact. The inserted cylinder cores (inserts) can easily be used in other cylinder designs (half cylinders, knob cylinders, camlock cylinders, etc.).

Cam position - Cam adjustment

Standard setting: 30° right with marking point seen from the front of the cylinder

1. unscrew the cover on the back of the cylinder using a coin or screwdriver
2. remove clutch and driving hub
3. set up the cylinder on the template and turn the driver to the desired position
4. push the driving hub into the housing according to the sketch
5. insert the clutch into the driving hub
6. screw the cover back in until it is level with the body

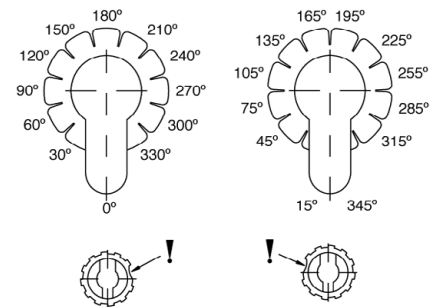

Standard drilling protection

The standard drilling protection is achieved by standard hardened steel locking elements and a hardened insert fixing screw (A).

This design complies with DIN EN 1303 attack resistance class B.

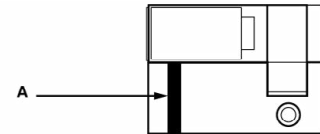

Increased drilling protection - VdS class B approval

By using additional steel elements in the body and insert, a higher resistance to drilling is achieved. Class B locking cylinders do not have an integrated pull-out protection. In combination with a tested core protection fitting, attack resistance class D is achieved.

- A = insert with two carbide length pins = BS
- B = tungsten carbide stud
- C = short insert fixing screw hardened at the front
- D = long insert fixing screw hardened at the rear

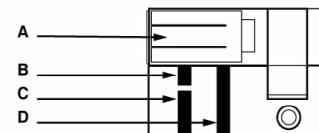

Largekey (clip and long bow)

- long key bow with extended key neck
- colour clip standard: black (selectable from 12 colors)
- when using e.g. protective fittings with core pulling protection rosette

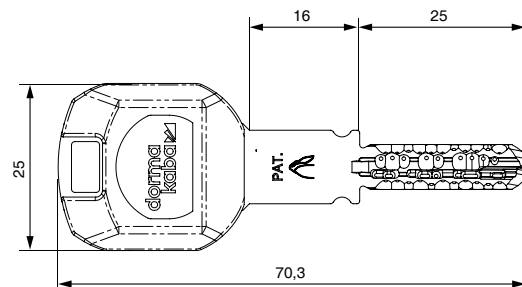

Long bow (armour bow)

- reversible key with armour bow
- when using e.g. security fittings with core pulling protection rosette and multiple locking systems

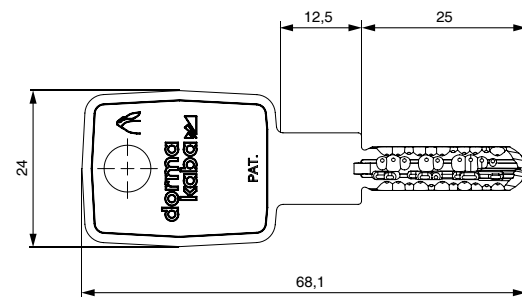

** on request